

NEXT BASE[®]

M
O
B
I
L
E

MODEL NO.
SDV620-B
OPERATING INSTRUCTIONS

E
N
T
R
A
I
N
M
E
N
T

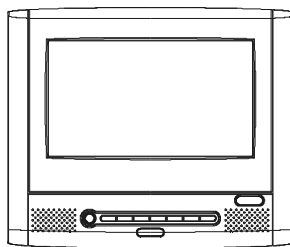

1. Read these instructions.
2. Keep these instructions.
3. Heed all warnings.
4. Follow all instructions.
5. Do not use this apparatus near water.
6. Clean only with dry cloth.
7. Do not block any ventilation openings. Install in accordance with the manufacturer's instructions.
8. Do not install near any heat sources such as radiators, heat registers, stoves, or other apparatus (including amplifiers) that produce heat.
9. Do not defeat the safety purpose of the polarized or grounding-type plug. A polarized plug has two blades with one wider than the other. A grounding type plug has two blades and a third grounding prong. The wide blade or the third prong are provided for your safety. If the provided plug does not fit into your outlet, consult an electrician for replacement of the obsolete outlet.
10. Protect the power cord from being walked on or pinched particularly at plugs, convenience receptacles, and the point where they exit from the apparatus.
11. Only use attachments/accessories specified by the manufacturer.
12. Use only with the cart, stand, tripod, bracket, or table specified by the manufacturer, or sold with the apparatus. When a cart is used, use caution when moving the cart/apparatus combination to avoid injury from tip-over.



13. Unplug this apparatus during lightning storms or when unused for long periods of time.
14. Refer all servicing to qualified service personnel. Servicing is required when the apparatus has been damaged in any way, such as power-supply cord or plug is damaged, liquid has been spilled or objects have fallen into the apparatus, the apparatus has been exposed to rain or moisture, does not operate normally, or has been dropped.
15. To Reduce the Risk of Fire or Electric Shock, Do not Expose This Appliance To Rain or Moisture.
16. The Shock Hazard Marking and Associated Graphical Symbol is provided on the bottom panel of unit.
17. Apparatus shall not be exposed to dripping or splashing and no objects filled with liquids, shall not be placed on the apparatus.

NOTE:

This battery pack (PS530P-E, PS5XXX-X) is just for SDV620-B and SDV620-XX use only.

Thank you for purchasing this Tablet DVD player. Please read this manual carefully before operating and reserve it for future reference. It will be helpful to you if you encounter any operational problem.

WARNING: TO REDUCE THE RISK OF FIRE OR ELECTRIC SHOCK, DO NOT EXPOSE THIS APPLIANCE TO RAIN OR MOISTURE, DRIPPING OR SPLASHING AND THAT NO OBJECTS FILLED WITH LIQUIDS, SUCH AS VASES, SHALL BE PLACED ON THE APPARATUS. DANGEROUS HIGH VOLTAGES ARE PRESENT INSIDE THE ENCLOSURE. DO NOT OPEN THE CABINET. REFER SERVICING TO QUALIFIED PERSONNEL ONLY.

ATTENTION: TO PREVENT ELECTRIC SHOCK, MATCH WIDE BLADE OF PLUG TO WIDE SLOT, FULLY INSERT.

LASER: This Digital Video Disc player employs a Laser System. To ensure proper use of this product, please read this owner's manual carefully and retain for future reference. Should the unit require maintenance, contact an authorized service location - see service procedure.

Use of controls, adjustments or the performance of procedures other than those specified may result in hazardous radiation exposure.

To prevent direct exposure to laser beam, do not try to open the enclosure.

Visible and invisible laser radiation when open and interlocks defeated.

DO NOT STARE INTO BEAM

LASER

Type	Semiconductor laser GaAlAs
Wave length	650 nm/780nm
Output Power	5mW
Beam divergence	60degree

**CLASS 1
LASER PRODUCT**

CAUTION:

These servicing instructions are for use by qualified service personnel only. To reduce the risk of electric shock, do not perform any servicing other than that contained in the operating instructions unless you are qualified to do so.

WARNING:

To reduce the risk of fire or electric shock, do not expose this appliance to rain or moisture.

CAUTION:

Use of controls or adjustments or performance of procedures those specified may result in hazardous radiation exposure.

CAUTION**RISK OF ELECTRIC SHOCK. DO NOT OPEN**

To reduce the risk of electric shock, do not remove cover (or back).
No user serviceable parts inside. Refer servicing to qualified service personnel.



SA 1965

**DANGEROUS
VOLTAGE**

The lightning flash with arrowhead symbol, with in an equilateral triangle, is intended to alert user to the presence of uninsulated “dangerous voltage” within the product enclosure that may be of sufficient magnitude to constitute a risk of electric shock to persons.



SA 1966

INSTRUCTION

The exclamation point within an equilateral triangle is intended to alert the user to the presence of important operating and maintenance (servicing) instruction in the literature accompanying the appliance.

**CAUTION:**

**INVISIBLE LASER RADIATION WHEN OPEN AND
INTERLOCK FAILED OR DEFEATED.
AVOID DIRECT EXPOSURE TO LASER BEAM.**

MACROVISION: This product incorporates copyright protection technology that is protected by U.S. patents and other intellectual property rights. Use of this copyright protection technology must be authorized by Macrovision, and is intended for home and other limited viewing uses only unless otherwise authorized by Macrovision. Reverse engineering or disassembly is prohibited.

DOLBY: Manufactured under license from Dolby Laboratories. "Dolby" and the double-D symbol are trademarks of Dolby Laboratories.

	IMPORTANT SAFETY INSTRUCTIONS.....1
PRECAUTIONS	PRECAUTIONS.....2
TABLE OF CONTENTS	TABLE OF CONTENTS.....5
CAUTIONS ON USING THIS PLAYER	CAUTIONS ON USING THIS PLAYER.....7
DISCS PLAYABLE	TYPES OF DISCS PLAYABLE ON THIS PLAYER.....9
PACKAGE CONTENTS	PACKAGE CONTENTS.....10
PARTS AND CONTROLS	FRONT SIDE.....11
	RIGHT & LEFT SIDE.....11
	BUTTON DEFINITION.....12
	MAIN UNIT REAR SIDE.....13
	HOW TO STAND.....13
	REMOTE CONTROL.....14
	KEY DESCRIPTION OF REMOTE CONTROL.....15
	NOTES ON USING THE REMOTE CONTROL UNIT.....16
	REPLACING THE BATTERY.....16
PRECAUTIONS FOR BATTERY PACK OPERATION	OPERATION OF THE BATTERY PACK.....17
	STORAGE.....17
	SERVICE LIFE AND DISPOSAL.....17
AUDIO / VIDEO CONNECTIONS	CONNECTING THE PLAYER TO A TV SET..... 18
	CONNECTING ADAPTER TO THE DC 12V SOCKET.....19
	USING THE EARPHONE.....19
CONNECTING THE PLAYER TO OTHER DEVICES	CONNECTING TO A DOLBY DIGITAL / MPEG DECODER OR AN AMPLIFIER WITH A BUILT-IN DECODER.....20
	CONNECTING TO A DIGITAL AMPLIFIER THAT IS NOT DOLBY DIGITAL / MPEG COMPATIBLE..... 21
	CONNECTING TO ACTIVE SPEAKER SYSTEMS.....22
USING THE BATTERY	NOTES FOR RECHARGING..... 23
	INSTALLING THE BATTERY PACK..... 23
	REMOVING BATTERY PACK.....24
	AC POWER OPERATION.....24
THE AV IN/OUT FUNCTION	THE AV IN / OUT FUNCTION..... 25

BASIC OPERATIONS	TURNING ON THE POWER.....	26
	TURNING OFF THE POWER.....	26
	LOADING.....	27
	PLAYBACK.....	28
	STOP PLAYBACK.....	28
	PAUSE PLAYBACK.....	28
	BOOKMARK PLAYBACK.....	28
	PLAYING AT FAST SPEED.....	29
	PLAYBACK IN SLOW MOTION.....	29
	A-B/REPEAT PLAYBACK.....	29
	ZOOM FUNCTION.....	30
	SEARCHING FOR A SPECIFIC SCENE.....	30
	SELECTING SUBTITLE.....	30
	CHANGING THE ANGLE.....	30
	CHANGING THE AUDIO LANGUAGE.....	30
	PROGRAM PLAYBACK.....	31
	RANDOM PLAYBACK.....	31
	USING THE ON-SCREEN DISPLAY.....	32
	PLAYING A MP3 FORMAT DISC AND JPEG CD.....	32
SETUP THE PLAYER	GENERAL STEPS OF SETUP.....	34
SYSTEM SETUP	TV SYSTEM.....	35
	TV TYPE.....	35
	SCREEN FORMAT.....	36
	TV SCREEN.....	36
	PASSWORD.....	37
	RATING.....	37
	DEFAULT.....	38
LANGUAGE SETUP	OSD LANGUAGE.....	39
	AUDIO LANGUAGE.....	39
	SUBTITLE LANGUAGE.....	40
	MENU LANGUAGE.....	40
AUDIO SETUP	AUDIO OUT.....	41
VIDEO SETUP	BRIGHTNESS.....	42
	CONTRAST.....	42
	HUE.....	43
	SATURATION.....	43
DIGITAL SETUP	OP MODE.....	44
	DYNAMIC RANGE.....	44
OTHERS	SIZE AND PARAMETER.....	45
	TROUBLE SHOOTING.....	46

CAUTIONS ON USING THIS PLAYER

1 DO NOT MOVE THE PLAYER DURING PLAYBACK

During playback, the disc spins at high speed. So do not lift or move the player. Doing so may damage the disc.

2 TRANSPORTING THE PLAYER

Before transporting the player, be sure to remove the disc and turn off the power, then unplug the power cord .

3 PLACE OF INSTALLATION

Select a stable place near the TV or stereo system to which you are going to connect the player.

Do not place the player on top of a TV or color monitor.

Install the player away from cassette decks or other devices which are easily affected by magnetic forces.

4 DO NOT PLACE OBJECTS ON THE TOP OF THE PLAYER

Do not expose this apparatus to rain, moisture, dripping or splashing and no objects filled with liquids, such as vases, shall be placed on the apparatus.

5 TURN OFF THE POWER WHEN NOT USING THE PLAYER

If the player is connected to your TV but not in use, switch the power off. It can avoid interference to your normal TV picture.

Noise problems may also be experienced if used near a radio.

6 SPECIAL NOTE REGARDING USE OF PLAYER IN VEHICLES

- We strongly advise against using the player while driving.
- Most countries and states have laws which prohibit or severely restrict the use of the player in vehicles while driving.
- Do not leave the player or the battery pack in places where the temperature is extremely low (about -10°C [14°F] or lower) or extremely high (about 60°C [140°F] or higher), such as inside the passenger cabin or trunk in midsummer. Doing so may warp the outer case or reduce the performance or quality of the battery pack.

7 WHEN USING WITH CAR POWER CABLE IN CARS

Please turn on the engine and then connect with the car power cable for using.

8 CLEANING THE PLAYER

Normally clean the player with a soft, dry cloth. For tough dirt, apply some neutral detergent diluted in 5 to 6 parts water to a soft cloth, wring out thoroughly.

Wipe off the dirt, then wipe off the player with a dry cloth. Note that alcohol, thinner, benzene, insecticides, etc., may cause the print or coating to peel off.



Also avoid leaving rubber or plastic products in contact with the player for long periods of time, as this may damage the cabinet. When using chemically treated cloths, read the cloth's instructions carefully. Always unplug the power cord from the power outlet before cleaning the player.

9 COPYRIGHTS

Unauthorized duplication, broadcast, public performance or rental of discs is prohibited by law.





TYPES OF DISCS PLAYABLE ON THIS PLAYER

- The discs listed on the table below can be played on this player without an adapter.
- The marks shown on the table below are indicated on the disc's label, package or jacket.

Types of playable discs and their marks	Diameter/Playable sides	Playback time
DVD-Video disc 	DVD video 12cm/single-sided 1 layer 12cm/double-sided 1 layer 2 layer	Playback time (MPEG 2 format) 133 minutes (4.7GB) 242 minutes (8.5GB) 266 minutes (9.4GB) 484 minutes (17GB)
	DVD video 8 cm/single-sided 1 layer 8 cm/double-sided 1 layer 2 layer	(MPEG 2 format) 41 minutes 75 minutes 82 minutes 150 minutes
	CD 12 cm/single-sided	74 minutes
	CD 8 cm/single-sided	20 minutes

Marks indicated on DVDs

DVD discs or packages include the marks shown below. These marks indicate the type of video or audio signals recorded on the disc and the functions that can be used.

Mark	Meaning
	Indicates the number of audio tracks.
	Indicates the number of angles.
	Indicates the selectable picture aspect ratio.
	Indicates the playable region number.

PACKAGE CONTENTS

After unpacking, first check the contents of your DVD player package as listed below:

Operating manual

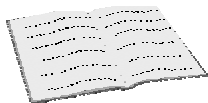

Main unit



AC / DC adapter



Audio and video cables



Card-type remote control unit

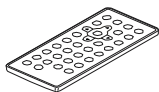

Battery

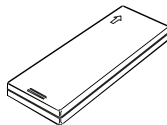

Car power cable



Car bag

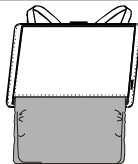

FRONT SIDE

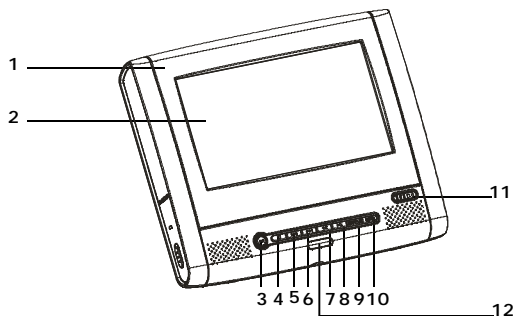

- | | |
|---------------------------------|--|
| 1 Disc compartment cover | 7 REV button |
| 2 TFT Screen | 8 FWD button |
| 3 PLAY / PAUSE button | 9 SUBTITLE button |
| 4 STOP button | 10 AUDIO button |
| 5 PREVIOUS button | 11 OPEN button (Push it to open the cover.) |
| 6 NEXT button | 12 Remote control sensor |

RIGHT & LEFT SIDE

RIGHT:

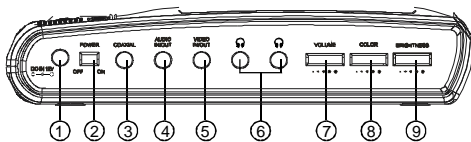

- | | |
|------------------------------|-----------------------------|
| 1 DC IN JACK (DC 12V) | 6 EARPHONE JACK |
| 2 POWER ON / OFF | 7 VOLUME CONTROL |
| 3 COAXIAL OUTPUT | 8 COLOR CONTROL |
| 4 AUDIO IN / OUT | 9 BRIGHTNESS CONTROL |
| 5 VIDEO IN / OUT | |

LEFT:

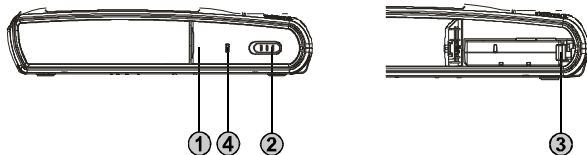

- ① BATTERY COMPARTMENT COVER
- ② COVER OPEN SWITCH
- ③ BATTERY LOCKER
- ④ BATTERY INDICATOR LED

1. Connecting adapter to the DC 12V socket



BUTTON DEFINITION

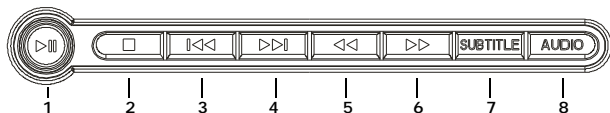

- 1** PLAY / PAUSE button
Press it to play. When pressing during playback, pause mode is set. Press it again to resume playback.
- 2** STOP button
Press it to stop playback.
- 3** PREVIOUS button
Press it to locate at the beginning of the previous tracks or chapters.
- 4** NEXT button
Press it to locate at the beginning of the next track or chapter.
- 5** REV button
Press it during playback to backward the playing speed through X2, X4, X8, X20, X1, X2.

- 6** FWD button
Press it during playback to forward the playing speed through X2, X4, X8, X20.
- 7** SUBTITLE button
Press it to switch the DVD's subtitle language.
- 8** AUDIO button
Press it to switch the audio language.

MAIN UNIT REAR SIDE

- 1** Support
The unit can stand with this device.

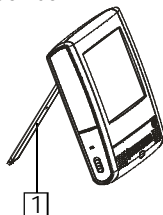

HOW TO STAND

- 1** Pull out the support.
- 2** Draw out the support to a proper position .
- 3** Pull down the button to lock it.

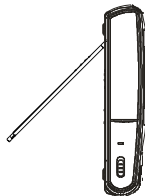
**1****2****3**

REMOTE CONTROL

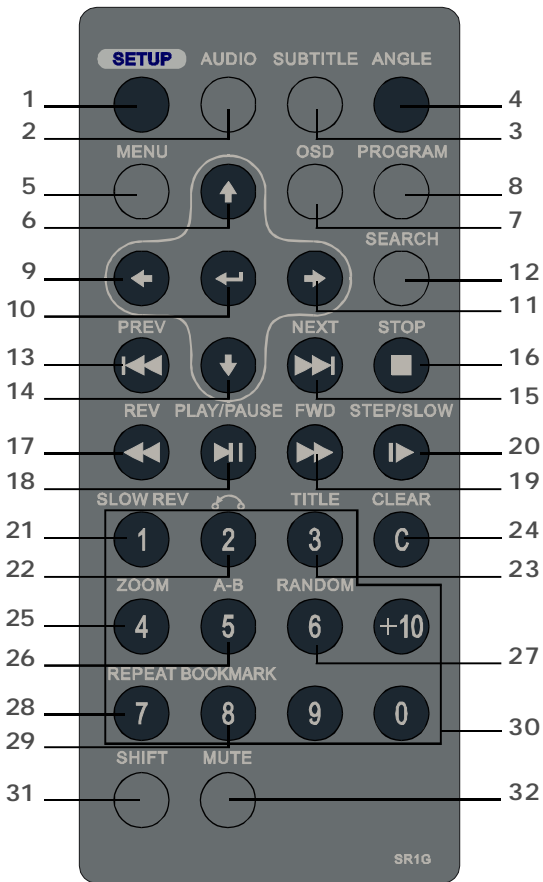

KEY DESCRIPTION OF REMOTE CONTROL

1 SETUP

Press this button to display setup screen when at stop status.

2 AUDIO

Press this button to switch the audio language.

3 SUBTITLE

Press this button to switch the DVD's subtitle language.

4 ANGLE

Press this button to switch angle.

5 MENU

Press this button to display the DVD's menu screen.
While playing VCD disk, press it to switch between menu on or off.

6 (↑)

Move the cursor up.

7 OSD

Press this button to display the disc information.

8 PROGRAM

Program playing order of tracks.

9 (←)

Move the cursor left.

10 ENTER(↵)

Enter the selected item.

11 (→)

Move the cursor right.

12 SEARCH

Locate title/chapter/ time to play.

13 PREV(⏮)

Jump to previous track.

14 (↓)

Move the cursor down.

15 NEXT(⏭)

Jump to next track.

16 STOP(■)

Press this button to stop playback.

17 REV(⏪)

Fast backward key.

18 PLAY/PAUSE (⏩)

Press this button to play or pause playback.

19 FWD(⏭)

Fast forward key.

20 STEP/SLOW(⏮)

During playing status, switch to SLOW mode. During pause status, switch to STEP mode.

21 SLOW REV

Slow backward key.

22 RETURN

Return back to menu screen.
If menu setting is off when playing VCD, the key is invalid.

23 TITLE

Press this button to display the DVD's title.

24 CLEAR

Clear the numbers inputted before.

25 ZOOM

Zoom the picture on screen.

26 A-B REPEAT

Press this button during playback to set two points and play the section between them repeatedly.

27 RANDOM

Play tracks randomly.

28 REPEAT

For DVDs, use this button to play titles or chapters repeatedly. For CDs, use this button to play tracks or the entire disc repeatedly.

29 BOOKMARK

Setup bookmark for playing.

30 NUMBER KEYS

Input number.

31 SHIFT

Press this button to switch between number & function. (Default: function)

32 MUTE

Press this button to mute the player.

NOTES ON USING THE REMOTE CONTROL UNIT

- Do not drop or step on the remote control unit or subject it to shocks.
- Note that the remote control unit may not work if there are obstacles between it and the remote sensor.
- Do not expose the remote sensor to strong light. Doing so may make operation impossible.
- Use the remote control unit within the specified operating range.

REPLACING THE BATTERY

- 1** Insert your finger nails into A and B on the diagram below, press A according to the direction, then pull out the battery holder.

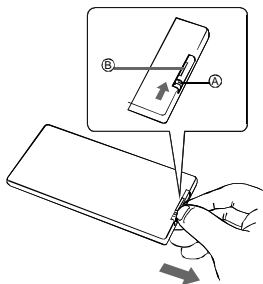

- 3** Fit the battery holder back to its place.

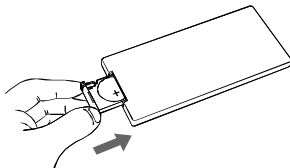

- 2** Remove the old battery, then insert the new battery into the battery holder with the + side facing upwards.

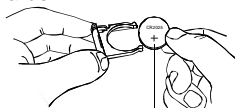

Lithium battery (CR2025)

NOTE:

- To prevent leakage of fluid from the lithium battery, remove the battery when not using the remote control unit for long periods of time (one month or more). If the battery leaks fluid, carefully wipe it out of the battery case, then change to a new lithium battery.
- Caution: The battery may present a risk of fire if mistreated. Do not recharge, disassemble, heat it above 100°C [212°F]. Replace battery with the same type.
- Dispose of used battery properly, keep away from children and do not dispose of in fire.

OPERATION OF THE BATTERY PACK

- Charge the battery pack fully before using it for the first time.
- When the surrounding temperature is high, the battery pack may sometimes be unusable due to activation of protection circuitry.
- When the tablet DVD player is used with the battery pack and has no disc or stops for about 10 minutes with power on, it will turn off automatically. (Auto power off)
The battery pack and the tablet DVD player become hot during use. This is not malfunction.
- When the battery pack is not to be used for a long period, be sure to remove it from the tablet DVD player. If the battery pack is left attached, continual flow of weak current renders it overdischarged and eventually unusable even when you try to charge it later.
- If the tablet DVD player is switched on while the battery pack is not fully charged, the operation may sometimes be unstable. Be sure to charge the battery pack fully before use.

STORAGE

- The battery pack should be stored under a surrounding temperature between 15°C [59°F] and 25°C [77°F]. Avoid storing it under extremely low temperature, in a place with high temperature and high humidity or in a place subject to soot, etc.
- When the battery pack is stored for a long period, at least once a year it is recommended to discharge it fully on the tablet DVD player, recharge it fully again and store it.

SERVICE LIFE AND DISPOSAL

- When the charging time or available operation time becomes extremely short, the battery may reach the end of its life. The battery pack can be used for about 300 cycles of recharging and operations.
- To dispose of a used battery pack, wrap a piece of tape around the terminal section and treat it in compliance with your local regulations.

Caution:

- Danger of explosion if battery is incorrectly replaced.
- Replace only with the same or equivalent type.

CONNECTING THE PLAYER TO A TV SET

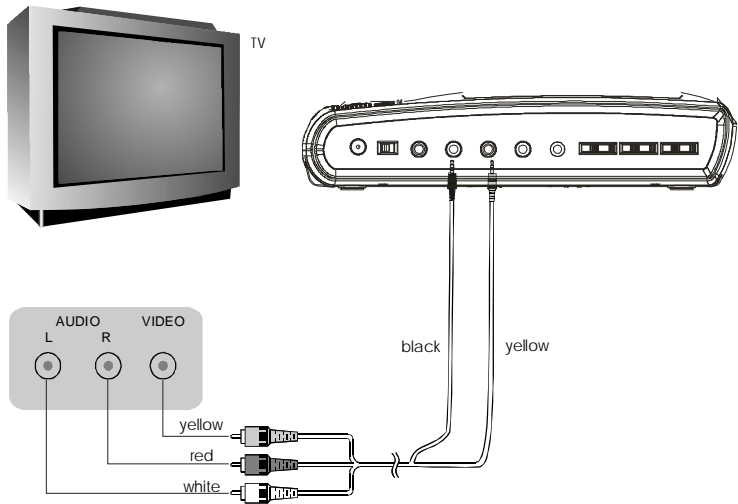

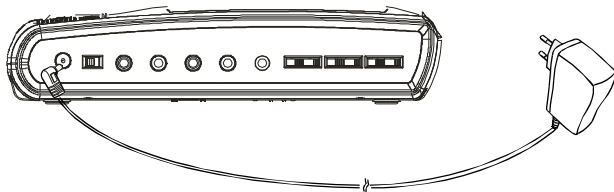
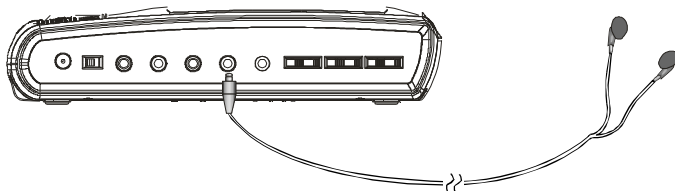
CONNECTING ADAPTER TO THE DC 12V SOCKET**USING THE EARPHONE**

1. Set the volume control to minimum sound level.
2. Connect the plug of earphone to the player's "  " jack.
3. Adjust the volume control to the preferred sound level.
4. The player has two earphone jacks. So two users can use earphones at the same time.

CONNECTING TO A DOLBY DIGITAL / MPEG DECODER OR AN AMPLIFIER WITH A BUILT-IN DECODER

This player can be used to enjoy powerful Dolby Digital, or MPEG sound. Output the digital signal from the player to a decoder or amplifier with built-in decoder.

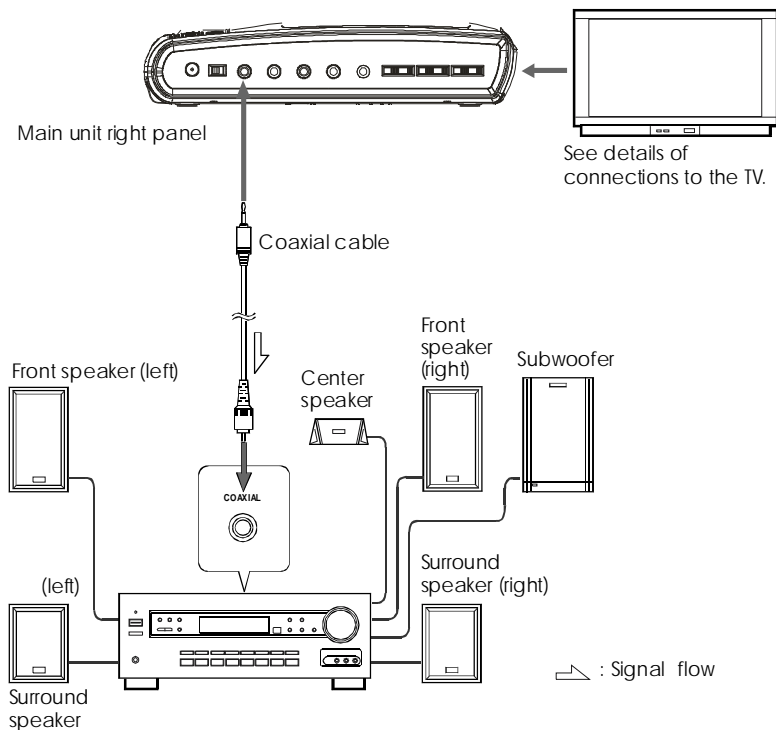

Hint:

A compatible decoder or amplifier, 5 speakers (front left/right, center and surround left/right) and a subwoofer are required to enjoy Dolby Digital sound.

CONNECTING TO A DIGITAL AMPLIFIER THAT IS NOT DOLBY DIGITAL / MPEG COMPATIBLE

For instructions of audio settings, refer to AUDIO OUT of AUDIO SETUP.

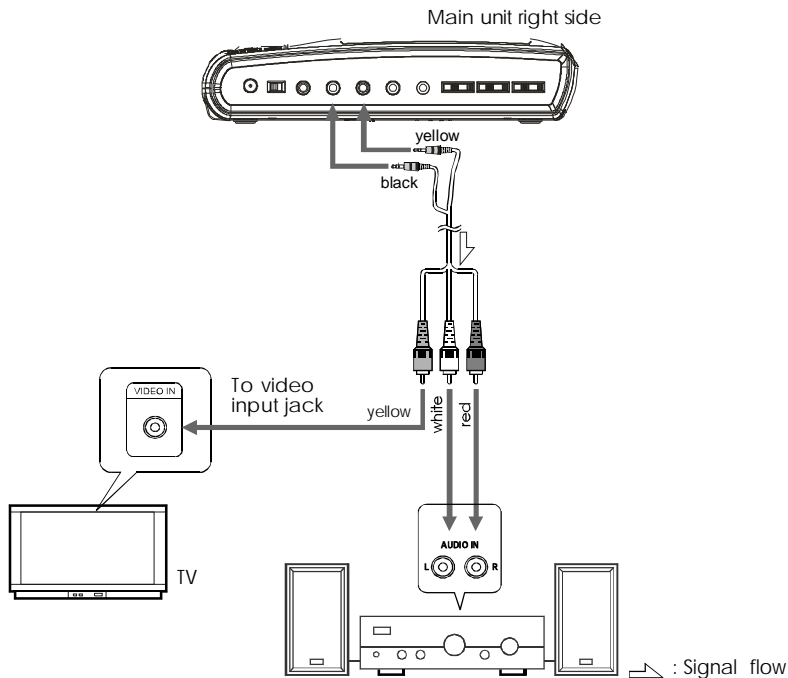
**NOTE:**

- Carefully check the player's digital output settings before connecting the player to an amplifier equipped with a digital audio input jack which is not Dolby Digital / MPEG compatible.

Playing DVDs when the audio settings are not correct may cause strong noise and may damage your speakers.

CONNECTING TO ACTIVE SPEAKER SYSTEMS

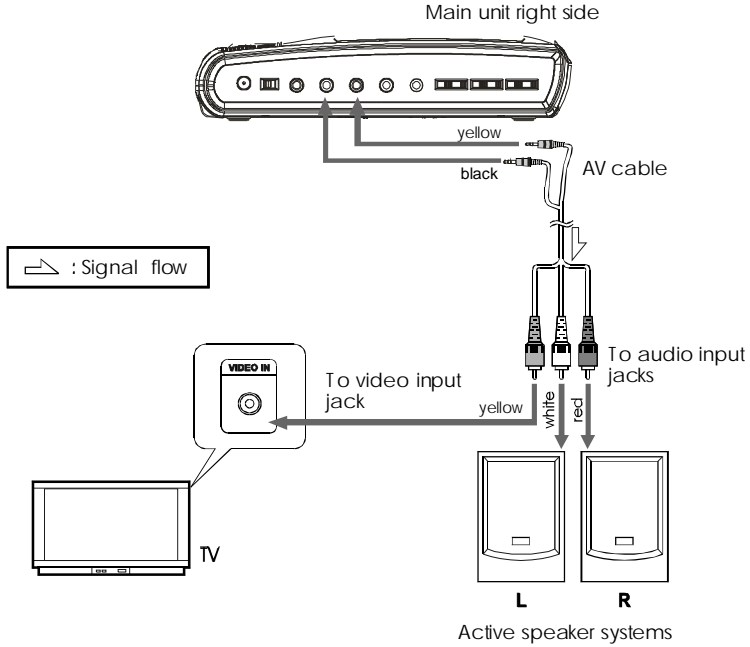



NOTES FOR RECHARGING

- When the battery pack is hot, it may take longer time than usual for recharging or may sometimes be unable to be recharged. Wait for the battery pack to cool down before retrying recharging.
- To protect the battery pack, do not recharge a fully charged battery pack repeatedly. Repeated overcharging may deteriorate the battery performance.
- The battery pack becomes hot after recharging, but this is not malfunction.
- When the battery pack is recharged in a hot environment, it may not recharge fully.
- The temperature during recharging affects the recharging efficiency. Recharging is in the most efficient state among temperatures from 10°C [50°F] to 30°C [86°F]. Place the battery charger in a place within this temperature range whenever possible.

INSTALLING THE BATTERY PACK

Insert the battery pack to the player as described below.

- 1 Insert the battery pack with the arrow head upward to the battery compartment according to arrow direction.**
 - 2 If the battery pack is locked, a "click" will be heard.**
 - 3 Close the battery compartment cover. Now the player can be operated.**
- When the battery pack is fully charged, the player can play DVDs for over 2.5 hours continuously.
 - If the power is switched on while the battery pack is not fully charged, the player operation may sometimes become unstable. Be sure to charge the battery pack fully before use.

- Be sure to switch the power to "OFF" while recharging. It will take about 3 hours.
- Battery will be recharged slowly in AC power operation mode.
- When the battery is connected, turn on the player and press OSD button. Symbol "  " will be displayed. This symbol indicates the battery's capacity.
- While the battery is almost worn out, "  " will flash to remind you.

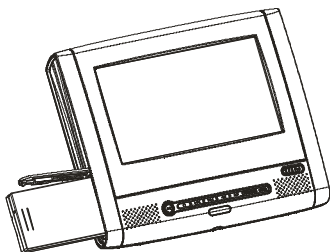

REMOVING BATTERY PACK

Set the power switch of the player to off, then operate as described below to remove the battery pack.

- 1 Slide the COVER OPEN SWITCH** of battery compartment to the OPEN position and the battery compartment cover will be opened.

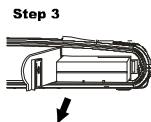
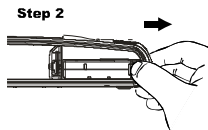
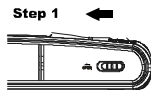

- 2 Switch the BATTERY LOCKER** to the right and the battery pack will be popped out.

- 3 Pull out the battery pack .**

AC POWER OPERATION

- 1** Connect the AC/DC adapter to the DC IN socket on player.
- 2** Connect the AC/DC adapter to the power outlet.
Now the player can be operated.

CAUTION:

- Be sure to use the AC/DC adapter provided with the player or provided by the right manufactory.
- Before inserting or removing the AC/DC adapter, always be sure to set the power switch of the player to off.

THE AV IN/OUT FUNCTION

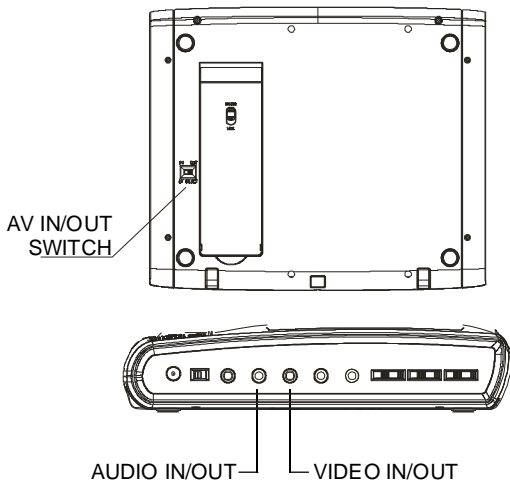

When push the **AV IN/OUT** switch to **IN**, the player will stop normal playback and act as a TFT MONITOR.

NOTE:

Avoid to input AV signal from AV JACK when the player is set to AV OUT, or interference will be caused to affect current playback and lower down playing quality.

Since the SCREEN FORMAT and TV SCREEN can not be adjusted at AV IN, please setup them right at AV OUT status and then switch to AV IN mode.

If no AV signal is inputted to the player when it has been set to AV IN mode, there will be no display on the screen.

TURNING ON THE POWER

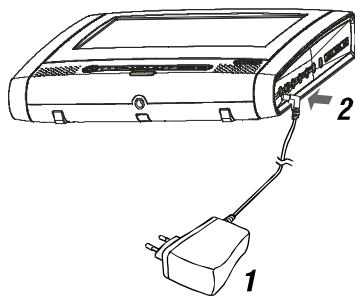

1 Connect the AC/DC adapter to power outlet.

2 Connect the DC output plug of the adapter to the DC input jack on the main unit.

3 Switch the POWER button to ON position.

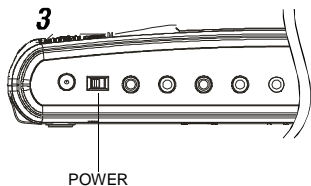
**Hint:**

The included AC/DC adapter is compatible with voltage from 100 to 240 V, you can use it on trips overseas.

Note that you need a converter plug (available in stores) suited for the region in which you are travelling.

TURNING OFF THE POWER

1 When the power is on, switch the power button to OFF position.

2 Unplug the power cord from the power outlet.

3 Disconnect the AC/DC adapter from the player's DC input jack.

LOADING

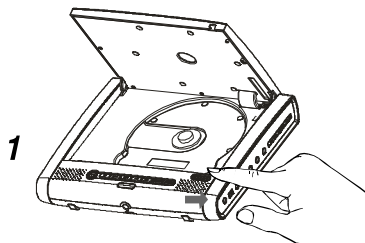

1 Press OPEN button and slide to open.

2 Place in disc and press down the disc with your fingers near the center hole.

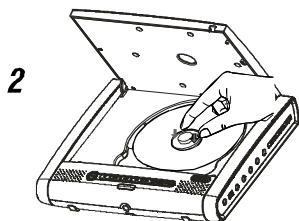

A click is heard.

Notes:

- Set the disc securely. Failure to set it securely could result in damage.
- Do not use cracked or warped discs. Doing so could result in damage.
- Place single-sided DVDs or CDs in with the label (printed) side facing upwards.
For double-sided DVDs, check each side carefully, then place the disc in securely (until a click is heard).
- For CDs or one-sided DVDs, you do not have to worry about touching the label (printed) side of the disc with your fingers. Since two-sided DVDs, have signals recorded on both sides, so be careful not to scratch them when removing them from the player.

3 Close the disc cover.

PLAYBACK

1. Turn on the power of the player.
2. Open the disc cover.
3. Insert a disc correctly.
4. Close the cover.
5. The player will load the disc and play automatically. If the disc cannot be played, push the ► button.

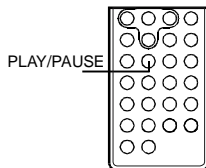

STOP PLAYBACK

- 1 Press ■ on the key board or on the remote control while playing.
- 2 The player remembers the stopping place.
- 3 To resume playback from the point where it stopped just press ► key.
- 4 To clear stopping mark, press ■ again at stop status. The player will not play from the stopping place when pressing ► next time.

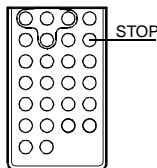

PAUSE PLAYBACK

- 1 Press ►/|| on the key board or on the remote control during playback.
- 2 Press ►/|| again to resume normal playback.

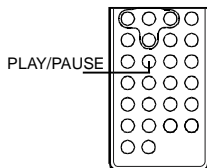

BOOKMARK PLAYBACK

- 1 Press BOOKMARK button during playback and use LEFT or RIGHT button to choose BOOKMARK 1 to 5.
- 2 Press ENTER button to setup this point as bookmark.
- 3 If you want to locate or cancel bookmark, press BOOKMARK button and use LEFT or RIGHT button to choose corresponding bookmark. Then press ►/|| button to locate or press CLEAR button to cancel.

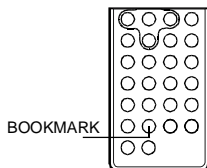

PLAYING AT FAST SPEED

- 1 Press ►► or ◀◀ button on the key board or just press on the remote control during playback.
- 2 The playback speed will be changed each time you pressing the ►► or ◀◀ .
The speed will be changed to 2X, 4X, 8X, 20X, 1X.

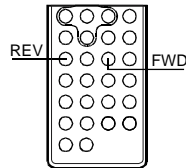

PLAYBACK IN SLOW MOTION

- 1 Press the ► button or SLOW REV button on the remote control during playback. The forward or backward speed becomes 1/2, 1/3, 1/4, 1/5, 1/6 or 1/7 of the normal speed each time you pressing the button.
- 2 When press ► during pause status, the player will show still picture on the screen. The picture will be changed one piece each time the button is pressed.

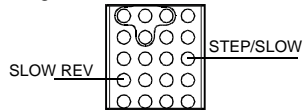

NOTE:

During fast playback or slow motion playback, the sound is muted except CD & MP3 disc playback. To resume normal playback, press ► .

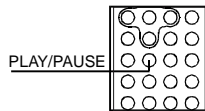

A-B/REPEAT PLAYBACK

- 1 A-B playback
 - Press A-B button on the remote control during playback, a point would be located on the remote control, and REPEAT A- appears on the screen.
 - Press A-B button again, B point would be located and the player would playback from A point to B point repeatedly.
 - Press A-B button again. A-B play would be cancelled and normal playback would be resumed.
- 2 Repeat a Title, Chapter or Track
 - Press the REPEAT button on the remote control during playback.
 - The chapter or the title(for DVD) and the track or entire disc (for CD) will be played repeatedly.
 - The REPEAT mode will be changed each time the repeat button is pressed.

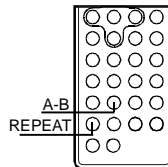

ZOOM FUNCTION

- 1 Press ZOOM on the remote control during playback. The picture on the screen is zoomed.
- 2 The zooming rate will be changed each time the zoom button is pressed, the sequence is 2X, 3X, 4X, 1/2X, 1/3X, 1/4X, 1X.
- 3 Use LEFT/RIGHT/UP/DOWN button to pan the picture if needed.

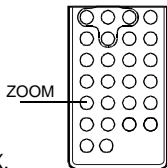

SEARCHING FOR A SPECIFIC SCENE

- 1 Press the SEARCH button on the remote control.
- 2 Press the UP, DOWN and ENTER button to move to the desired section.
- 3 Input valid number to choose specific time or title/chapter or track.
- 4 press ENTER button to play the specific scene.
- 5 Press SEARCH button to resume normal screen.

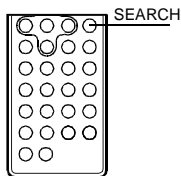

SELECTING SUBTITLE

You can select a preferred subtitle from those included on the DVD video disc by pressing SUBTITLE button on the remote control during playback.

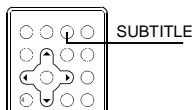

CHANGING THE ANGLE

Press the ANGLE button on the remote control while playing a scene recorded with multiple angles. If your DVD disc is not recorded with multiple angles, pressing ANGLE button will not effect at all.

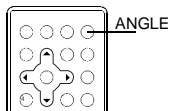

CHANGING THE AUDIO LANGUAGE

- 1 Press the AUDIO button on the remote control during playback. You can select audio language included on the DVD video disc.
- 2 For VCD or CD, you can choose the channel to play.

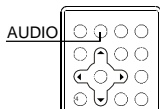

PROGRAM PLAYBACK

The program playback function can automatically playback titles, chapters, or tracks in the programmed order.

1. Insert a disc and then press the PROGRAM button on the remote control.

At this time, menu appears as below.

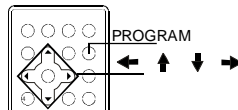
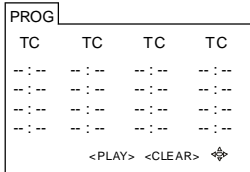

2. Using ←/ ↑/ ↓/ → and the number buttons, select the title and chapter in the order you want them to be programmed in.



3. Using ←/ ↑/ ↓/ → to move the cursor to **PLAY** and press ENTER button. The player starts PROGRAM playback.
4. To exit , press the PROGRAM again.

NOTES:

- When the DVD video player is turned off or the discs are removed, the programmed items will be removed.
- Depending on the disc, some may not have this function.
- Selecting an inexistent title or chapter, program playback cancels automatically.

RANDOM PLAYBACK

- Press RANDOM button during playback to show random playback status.
- Then press RANDOM button again to switch to ON or OFF.
- When random playback is ON, the tracks will be played randomly.

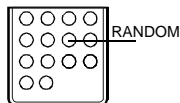

USING THE ON-SCREEN DISPLAY

- 1 This DVD video player allows you to view the operational status and disc information on screen.
- 2 For DVD discs, press OSD button once on the remote control during playback, the Title/Chapter/Playtime information will appear on the screen; Press secondly, the Subtitle/Audio /Angle information will appear; Press OSD button again, the information will disappear.
- 3 For VCD and CD discs, press OSD button, the Track/Repeat/Playtime information will appear; press the button again, the information will disappear.

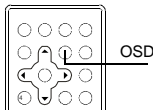



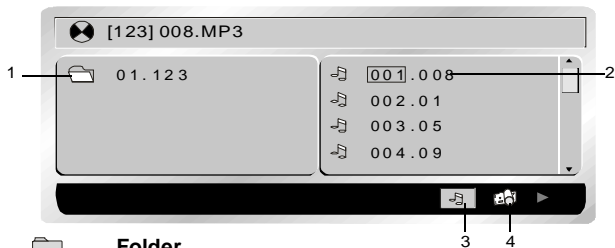

PLAYING A MP3 FORMAT DISC AND JPEG CD



1. **Folder**
2. **Files**
3. **MP3 ICON**
4. **JPEG ICON**

- Use to move the cursor to a folder, a file, MP3 ICON or JPEG ICON.
- In order to play Mp3 files, move the cursor to MP3 ICON and press ENTER button. In order to play JPEG files, move the cursor to JPEG ICON and press ENTER button.
- Choose the desired file and press ENTER to play.
- Press A-B button to have A-B REPEAT function; press REPEAT button to switch repeat mode(REP1, REP DIR, REP ALL, REP OFF). REP1 means repeating the track; REP DIR means repeating the folder; REP ALL means repeating the whole disc.

- You can press the NUMBER buttons to select the file you want to play. For example, if you desire the 15th track in current list, press the "+10" button once, then press "5". The 15th starts playback.
- When playing JPEG pictures, press the PROGRAM button to choose the pictures switched mode.
- When a picture is playing or at pause status, press the /// buttons to rotate the picture.
 - Up: flip vertical
 - Down: flip horizontal
 - Left: rotate 90 counter-clockwise
 - Right: rotate 90 clockwise
- When a JPEG list screen is displayed, press the MENU button, the screen displays small pictures. Up to 12 small pictures are displayed per screen. Press the NEXT button to go forward and the PREV button to go back to the previous page. You can also select and play a picture in full screen by pressing its number.

In order to return back JPEG List screen, press TITLE button.

GENERAL STEPS OF SETUP

1 Press the **SETUP** button on the remote control, the main setup menu appears.

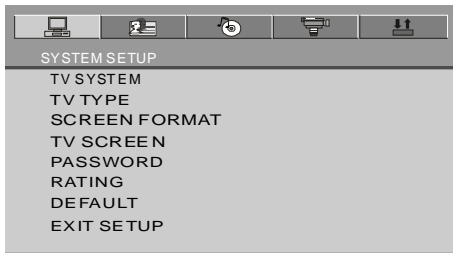

2 Press the **LEFT** and **RIGHT** buttons to highlight the icon of the desired page, then press the **DOWN** or **UP** button to activate that page.

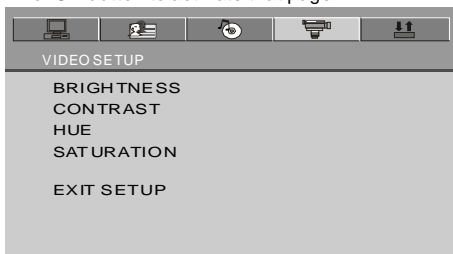

3 Press the **DOWN** button to highlight the desired option. Press **ENTER** or **RIGHT** to select the choices of that option appear .

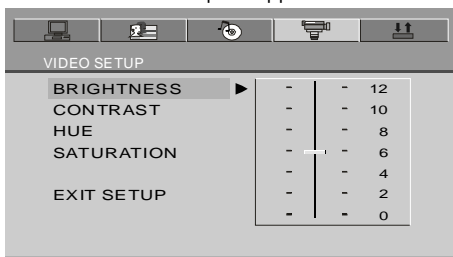

4 Press **LEFT/RIGHT/UP/DOWN** buttons to highlight the **EXIT SETUP** option, then press **ENTER** or **SETUP** again to exit **SETUP MENU**.

NOTE:

The pressing of the following buttons will turn off the setup menu, and the choices that have been changed will be saved: **SUBTITLE, STOP, PLAY / PAUSE, STEP, SEARCH, ANGLE, PROGRAM, PREV, MUTE, MENU, CLEAR, OSD, AUPID, REV, NEXT, FWD.**

The system setup options are illustrated below:

TV SYSTEM

If you want to connect the player to a TV, please choose a correct TV system first.

- AUTO: Choose this setting if your DVD player is connected to a multi-system TV.
- NTSC: Choose this setting if your DVD player is connected to a NTSC TV.
- PAL: Choose this setting if your DVD player is connected to a PAL TV.
- The default setting is NTSC.

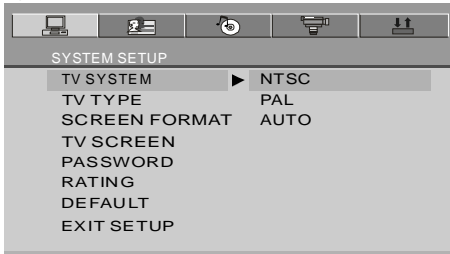

NOTE:

Setting with incorrect TV system will result in black and white picture on your TV screen.

TV TYPE

16 : 9 (Wide Screen): Choose this setting if your DVD player is connected to a wide screen TV. If you choose this setting and you don't have a wide screen TV, the images on the screen may appear distorted due to vertical compression.

4 : 3 LB (Letter Box): Choose this setting if your DVD player is connected to a normal ratio TV. You'll see the movies in their original aspect ratio (height-to-width ratio). You'll see the entire frame of the movie. The movie might appear with black bars at the top and bottom of the screen.

4 : 3 PS (Pan & Scan): Choose this setting if your DVD player is connected to a normal ratio TV. You can fill the movie to the entire screen of your TV. This might mean that parts of the picture (the left and right edges) won't be seen.

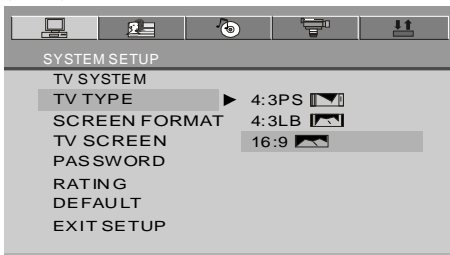

NOTES:

- The image display ratio is related to the recorded disc format. Some discs can not be displayed in the aspect ratio choosen.
- If you play a disc recorded in 4:3 format on a wide screen TV, black bars will appear on the left and right side of the screen.
- You must adjust the screen setting depending on the type of the TV.

SCREEN FORMAT

16:9 Choose this setting to change SCREEN FORMAT to 16:9.

4:3 Choose this setting to change SCREEN FORMAT to 4:3.

The default setting is 16:9.

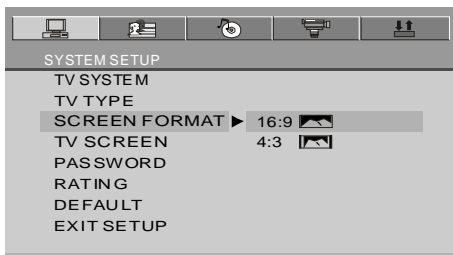

TV SCREEN

NORMAL: Choose this setting to have obverse display.

ROTATE 180°: Choose this setting to have reverse display.

The default setting is NORMAL.

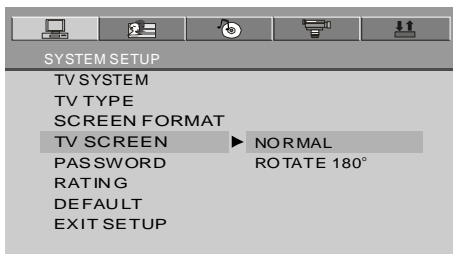

PASSWORD

The PASSWORD option allows you to set up the rating limits and lock your player to control the type of content your family watches. The parental control feature is a rating system for DVDs, like movie ratings.

When the player is locked, you need to enter the password in order to play discs that have a higher rating than what you've allowed. If the player is unlocked, no password is required to play discs. Even if you've set rating limits, they won't be enforced until the player is locked.

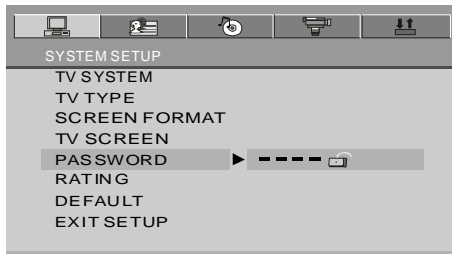

NOTES:

There is no prest password when the player is shipped from the factory. It is unlocked, if you want to use the PASSWORD feature, you must set the rating limits and lock the player with the menu.

Once the player is unlocked, you can change the password to any 4-digit number.

If you forget your password, enter the factory preset password: 0000.

RATING

The rating feature works with DVD discs that have been assigned a rating. This helps you to control the types of DVDs that the player can be watched.

- There are eight limited rating options: KID SAFE, G, PG, Pg13, PG-R, R, NC-17, ADULT.
- The default setting is ADULT.

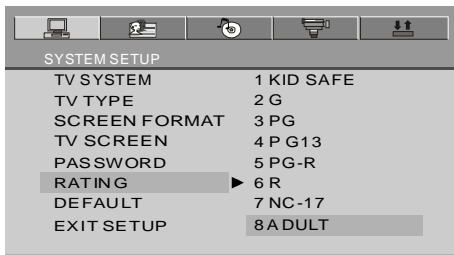
**NOTE:**

The player must be uncocked before you can change any rating settings.

DEFAULT

Choose this option to resume settings except password and rating.

The language setup options are illustrated below:

OSD LANGUAGE

Highlight the OSD LANGUAGE option, and press the Arrow buttons to choose the OSD language you prefer. Press ENTER to confirm, and it will display OSD in that language. There are 5 optional OSD languages :ENGLISH,GERMAN,SPANISH, FRENCH and ITALIAN .

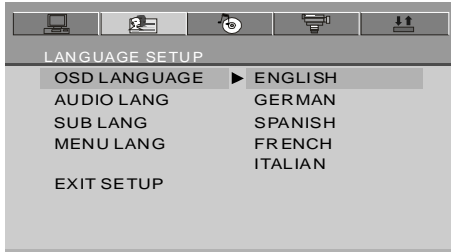

AUDIO LANGUAGE

Highlight the AUDIO LANG option, and press the Arrow buttons to choose the audio language you prefer. Press ENTER to confirm. If the disc you are playing has that language available, it will output audio in that language. There are 8 optional audio languages: CHINESE, ENGLISH, JAPANESE, FRENCH, SPANISH, PORTUGUESE, ITALIAN and GERMAN .



SUBTITLE LANGUAGE

Highlight the SUB LANG option, and press the Arrow buttons to choose the subtitle language you prefer. Press ENTER to confirm. If the disc you are playing has that language available, it will display subtitles in that language. There are 7 optional subtitle languages: CHINESE, ENGLISH, JAPANESE, FRENCH, SPANISH, ITALIAN and GERMAN.

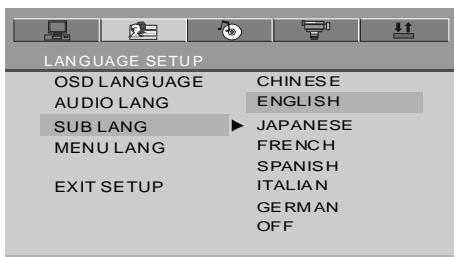

MENU LANGUAGE

Highlight the MENU LANG option, and press the Arrow buttons to choose the menu language you prefer. Press ENTER to confirm. If the disc you are playing has that language available, it will display menu in that language. There are 8 optional menu languages: CHINESE, ENGLISH, JAPANESE, FRENCH, SPANISH, PORTUGUESE, GERMAN and ITALIAN.

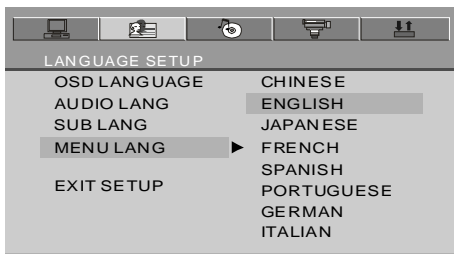

NOTE:

If your preferred language isn't available, the disc's default language will be played. The default language of your DVD player is English.

AUDIO OUT

Highlight the AUDIO OUT option, and press the Arrow buttons to choose the audio output mode you prefer. Press ENTER to confirm:

There are 3 optional audio output modes: SPDIF/OFF, SPDIF / RAW and SPDIF/ PCM.

- SPDIF/OFF: Choose this setting to output analog signal, and there will be no signal outputted from coaxial jack.
- SPDIF/ RAW: Choose this setting if your DVD player is connected to a power amplifier with a coaxial cable. When playing a disc recorded with Dolby Digital, and MPEG audio formats, the corresponding digital signals will be outputted from the Coaxial Output jack.
- SPDIF / PCM: Choose this setting if your DVD player is connected to a 2-channel digital stereo amplifier. When playing a disc recorded with Dolby Digital and MPEG audio formats, audio signals will be modulated into a 2-channel PCM signal, and it will be outputted from the Coaxial Output jack .

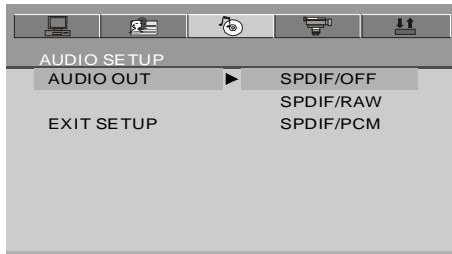

The video setup options are illustrated below:

BRIGHTNESS

Use the UP and DOWN buttons to move the scroll and adjust the brightness.

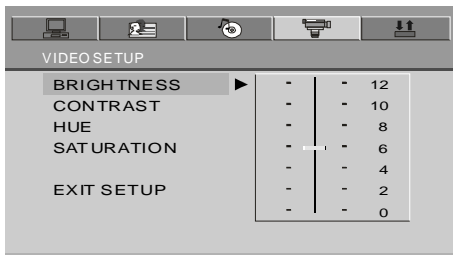

CONTRAST

Use the UP and DOWN buttons to move the scroll and adjust the contrast.

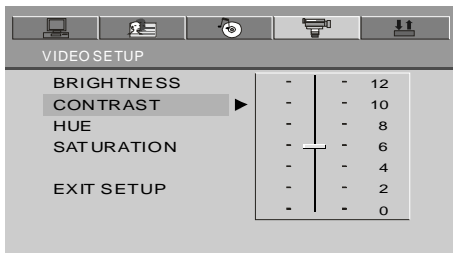

HUE

Use the UP and DOWN buttons to move the scroll and adjust the hue.

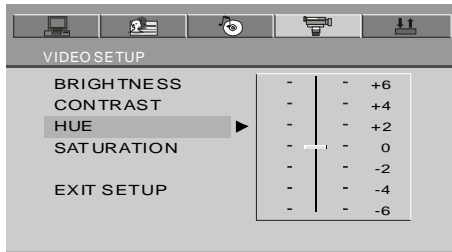

SATURATION

Use the UP and DOWN buttons to move the scroll and adjust the saturation.

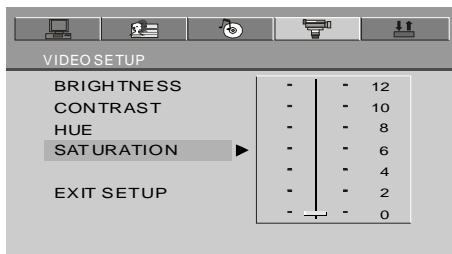

The digital setup options are illustrated below:

OP MODE

There are two output modes: one is LINE OUT; the other is RF REMOD.

LINE OUT: To carry out the linear compression function for input signal.
Choose it in the evenings for the sake of its low volume.

RF REMOD: Choose it during the daytime for the sake of its high volume.

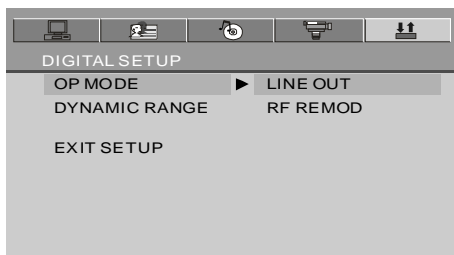

DYNAMIC RANGE

DYNAMIC RANGE: Choose this setting to adjust the line out compressing ratio and get different effects. If adjusting to FULL, the audio signal peak value will be compressed to be minimum; while adjusting to OFF, to be maximum.

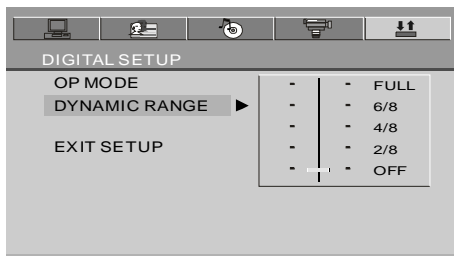

SIZE AND PARAMETER

Product name:	TABLET DVD player
Power:	DC12V
Consumption:	<8.5W
Audio out:	R/L 2ch, COAXIAL
Video out:	Composite
Size:	216X182X38.2mm
Weight:	780g (W/O battery)

TROUBLE SHOOTING

Symptoms	Possible causes	Remedies
The disc does not play	Load the disc incorrectly.	Load the disc with the label side up, and firmly pressed into center.
	Disc is dirty or scratched.	Make sure the disc is free from scratches or fingerprints.
	Wrong region disc.	Use right region disc.
No display	AV cable is disconnected.	Connect the cable firmly.
	The player is set to AV IN mode.	Input AV signal or change to AV OUT mode.
	Wrong setting or connection for the player or TV.	Setting or connecting correctly with your player or TV.
No sound	AV cable is disconnected.	Connect the cable firmly.
	Wrong setting or connection for the player or TV.	Setting or connecting correctly with your player or TV.

Maintenance Clean the unit only as recommended in the Operational Instructions.

DAMAGE REQUIRING SERVICE

Have the unit serviced by a qualified service technician if:

- The unit has been exposed to rain or water.
- The unit does not seem to operate normally.
- The unit exhibits a marked change in performance.

DO NOT ATTEMPT TO SERVICE THE UNIT BY YOURSELF!

